

# Power Supply



## ICL-SWPU-240W-24V

### CONSTANT VOLTAGE POWER SUPPLY - NON-DIMMING

Introducing our cutting-edge 24V LED drivers, designed to redefine lighting solutions. With an IP67 rating, they are built to withstand the toughest conditions, ensuring durability and longevity. Our drivers offer DALI compatibility, enabling precise control and customisation of your lighting environment. Featuring push-to-dim and on-off functionalities, they cater to diverse lighting needs. With an astonishing 100,000 hour lifespan, these drivers guarantee lasting performance, while their flicker-free technology ensures a soothing and eye-friendly illumination experience. Elevate your lighting projects with reliability, versatility and quality - choose our 24V LED drivers for a brighter and sustainable future.

<b>Watts:</b>	240W
<b>IP Rating:</b>	IP67
<b>Voltage:</b>	24V DC
<b>Input:</b>	120-240V 50/60Hz, 0.75A Max
<b>Output:</b>	24V : 0A (min) - 10A (max)
<b>Dimensions:</b>	188mm x 68.0mm x 38.5mm (including end caps)
<b>Operating Temperature:</b>	-40°C to +90°C
<b>Storage Temperature:</b>	-40°C to +85°C
<b>Great Surge Immunity:</b>	10kV
<b>Net Weight:</b>	830g
<b>Life:</b>	100,000 hours @ Tc ≥ 75°C
<b>Warranty:</b>	7 years
<b>Input Voltage:</b>	108 ~ 305 V
<b>Input Frequency:</b>	47~ 63Hz
<b>Power Factor:</b>	>0.9 @ 60-100% load, refer to PF vs load curve
<b>THD:</b>	<15% @ 60-100% load, refer to THD vs load curve
<b>Input Current:</b>	2.2A max @ 120 Vac & Full-Load 1.1A max @ 220 Vac & Full-Load
<b>Leakage Current:</b>	1mA max @ 277 Vac 60Hz, UL8750, 0.75mA max @ 240 Vac 50Hz, IEC61347-1
<b>Input Under Voltage:</b>	Shut down and auto-restart
<b>Surge Protection:</b>	Line to line 6kV, line to ground 10kV, IEC 61000-4-5
<b>Voltage Accuracy:</b>	±3% Vo
<b>Setup Time:</b>	1.2 seconds max
<b>Overshoot:</b>	10% Vo, max
<b>Output Over Current:</b>	120% Io, typ.
<b>Short Circuit:</b>	Auto Recovery. The output recovers when short is removed

# ICL-SWPU-240W-24V

<b>Over Temperature</b>	Turn off output when $T_c \geq 105 \pm 10^\circ\text{C}$ Auto recovery when $T_c \leq 70 \pm 10^\circ\text{C}$
<b>MTBF</b>	$\geq 280,000$ @ $T_c \geq 75^\circ\text{C}$ (MIL - HDBK - 217F)
<b>Case Temperature</b>	90°C max
<b>UL Class:</b>	P, ENEC/CB/CCC SELV Output
<b>Safety:</b>	According to EN 61147-1, 61347-2-3, 61347-2-13, 62384
<b>Class II:</b>	Available
<b>Input Over Voltage Protection:</b>	Not Available
<b>IEC 61347-1</b>	Lamp control gear Part 1 - general safety requirements
<b>IEC 61437-2-13</b>	Lamp control gear part 2-13 - particular requirement for d.c or a.c supplied electronic control gear for LED modules
<b>IEC 55015</b>	Conducted emission test & radiated emission test
<b>IEC 61000-3-2</b>	Harmonic current emissions - Class C
<b>IEC 61000-3-3</b>	Voltage fluctuations & flicker
<b>IEC 61000-4-2</b>	Electrostatic discharge (ESD) : 8kV air discharge, 4 kV contact discharge
<b>IEC 61000-4-3</b>	Radio frequencyelectromagnetic field susceptibility (RS)
<b>IEC 61000-4-4</b>	Electrical fast transient (EFT)
<b>IEC 61000-4-5</b>	Surge immunity test
<b>IEC 61000-4-6</b>	Conducted radio frequency disturbances test (CS)
<b>IEC 61000-4-8</b>	Power frequency magnetic field test
<b>IEC 61000-4-11</b>	Voltage dips
<b>IEC 61547</b>	Electromagnetic immunit requirements applies to lighting equipment

## Lifetime vs. Case Temperature

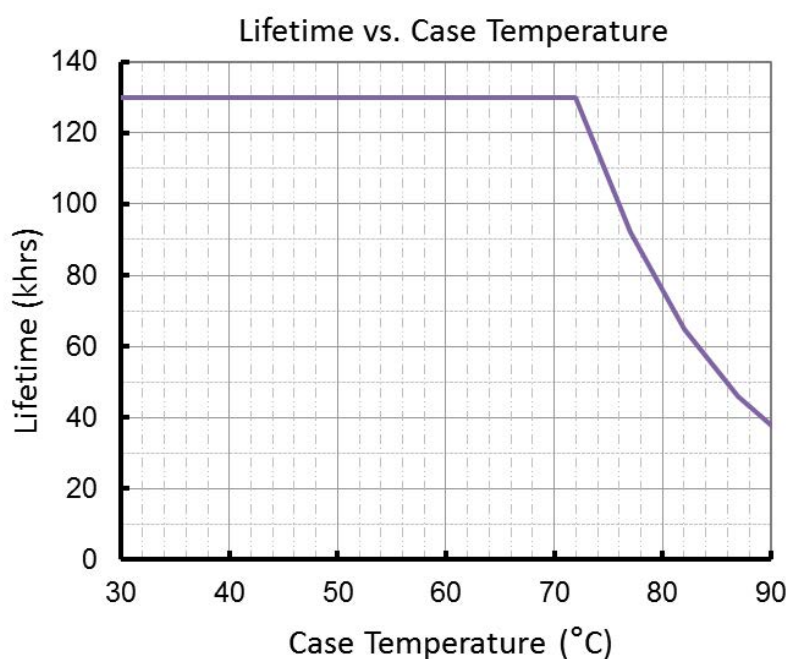

**End of Life:** Maximum Failure Rate = 10%

# ICL-SWPU-240W-24V

## Power Factor vs. Load

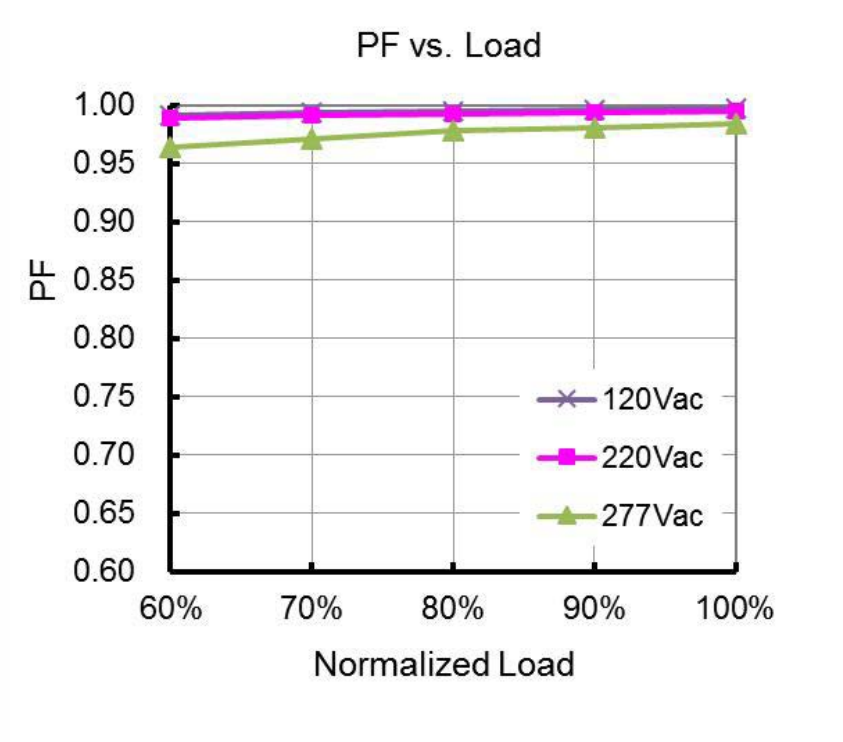

## THD vs. Load

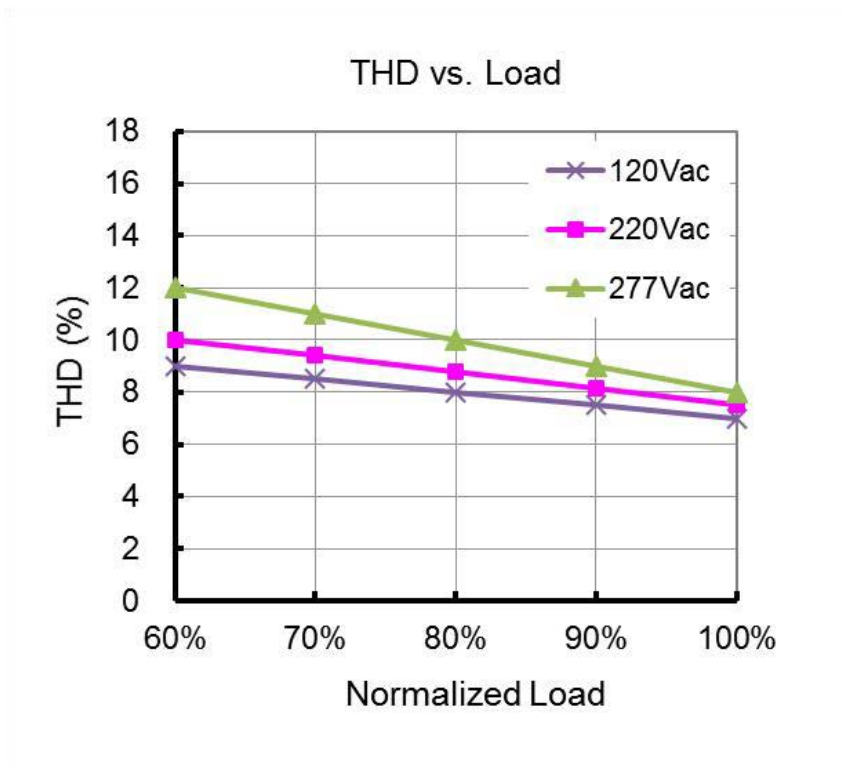

# ICL-SWPU-240W-24V

## Efficiency vs. Output Current

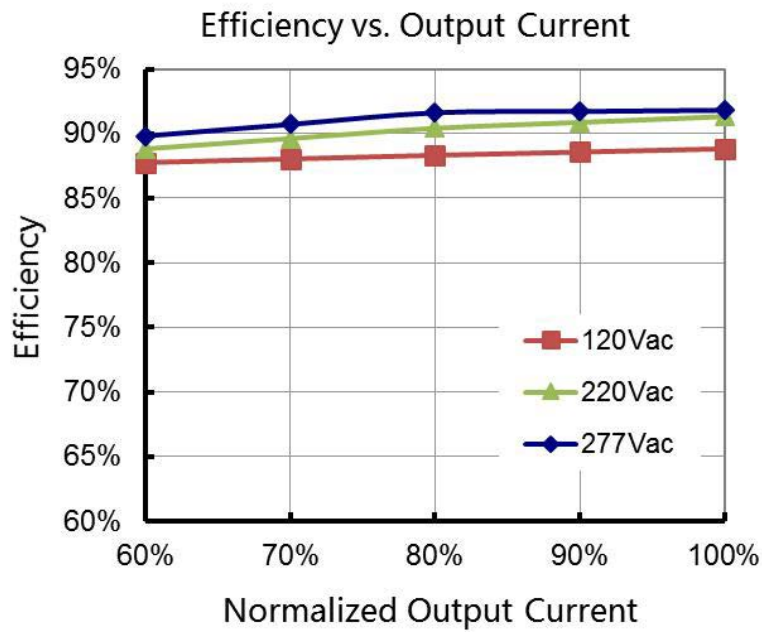

## Inrush Current

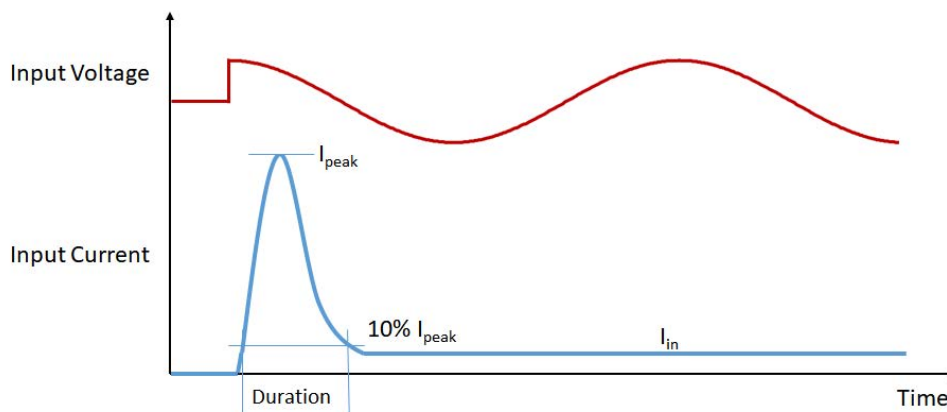

<b>Input Voltage 120Vac:</b>	$I_{peak}$ : 33.4A, Duration: 1.28mS
<b>Input Voltage 220Vac:</b>	$I_{peak}$ : 66A, Duration: 1.14mS
<b>Input Voltage 277Vac:</b>	$I_{peak}$ : 80.8A, Duration: 1.12mS

# ICL-SWPU-240W-24V

## Tc Point

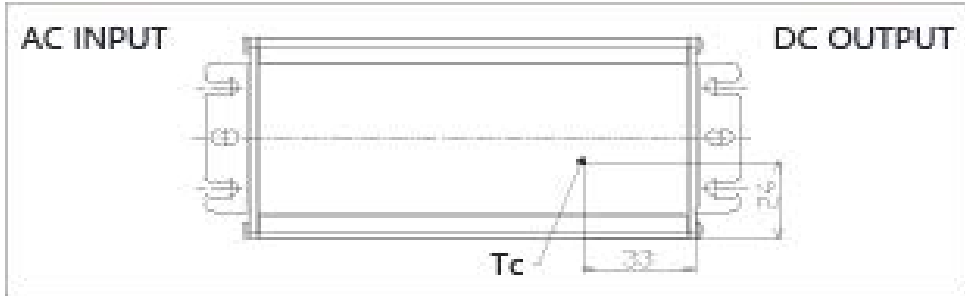

## Wiring Diagram

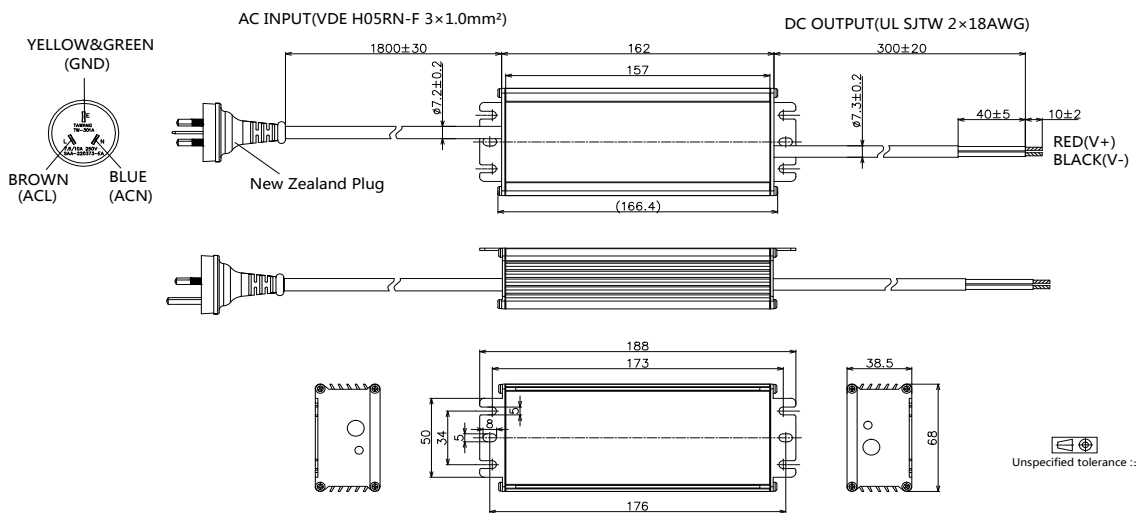

**CAUTION:**  
Risk of electric shock

Industrial Commercial  
Lighting is a New Zealand  
owned and operated  
lighting solutions company  
based in the South Island

We provide industrial, commercial,  
architectural, sports, design and  
consulting lighting services.

Contact us for more information, or  
to discuss how we can assist you with  
a tailored lighting solution.

Phone **03 385 2291**  
Email **[contact@iclighting.co.nz](mailto:contact@iclighting.co.nz)**

[www.iclighting.co.nz](http://www.iclighting.co.nz)

